

Let the fun BEGIN...



SK
SWING
KINGDOM

In your own
Backyard!



about us & mission	3
detailed quality	4
f.a.q.	5
color options.....	6



intro page	7
 A-1 Standard Climber	8
 A-4 Special.....	9
 A-5 White Tower	10
 KC-1 Clubhouse.....	11
 KC-2 Deluxe.....	12
 KC-5 Deluxe.....	13
 KC-8 Voyager.....	14
 KC-10 Economy Turbo	15









mountain climber series

intro page	16
 SK-1 Mini Mountain Climber....	17
 SK-2 Junior Mountain Climber ..	18
 SK-5 Mountain Climber.....	19
 SK-10 Mountain Climber	20
 SK-15 Mountain Climber	21
 SK-18 Turbo Mountain Climber ..	22
 SK-30 Mega Mountain Climber ..	23
 SK-40 Rocky Mountain Climber ..	24
 SK-50 Retreat	25



double tower series

intro page	26
 KTB-2 Turbo Tower	27
 A-7 Deluxe.....	28
 RC-5 Challenger.....	29
 RL-2 Turbo Tower.....	30
 RL-3 Super Tower.....	31
 RL-5 Combo Tower	32
 RL-10 Cliff Lookout	33





playhouse
SERIES

intro page 34



C-1 Hideout..... 35



C-2 Turbo Escape..... 36



C-3 Hideout..... 37



C-4 Hideout..... 38



C-5 Castle..... 39



C-8 Bridge Escape..... 40



C-3 Tunnel Escape..... 41



KRC Extreme .. 42 & 43



SK-60 Cottage Escape 44

accessories45-49

thank you 50

warranty 51

lawn swings Back

ABOUT us...



As a premier vinyl swing set manufacturer, Swing Kingdom is a family operated business that is striving to manufacture quality built, affordable swing sets that will provide you with loads of fun and family time.

Swing Kingdom started designing and manufacturing swing sets in 2000 in a 500 square foot building. The demand for high-quality virtually maintenance-free swing sets has grown so much that we needed to expand to our new 43,000 square foot facility. Swing Kingdom was the first manufacturer to utilize the superior combination of PVC and structural wood, topped off with stainless steel corner brackets and hardware for extra strength.

Our play sets are loaded with activities that will be sure to spark your child's imagination. Invite some friends over for some fun outdoor activities with your children.

OUR MISSION...

OUR MISSION AT SWING KINGDOM IS TO CREATE PROGRESSIVE SWING SETS FOR PARENTS WHO WANT TO GENERATE A RELATIONSHIP WITH THEIR CHILDREN IN THE EARLY YEARS OF PHYSICAL DEVELOPMENT.



detailed quality

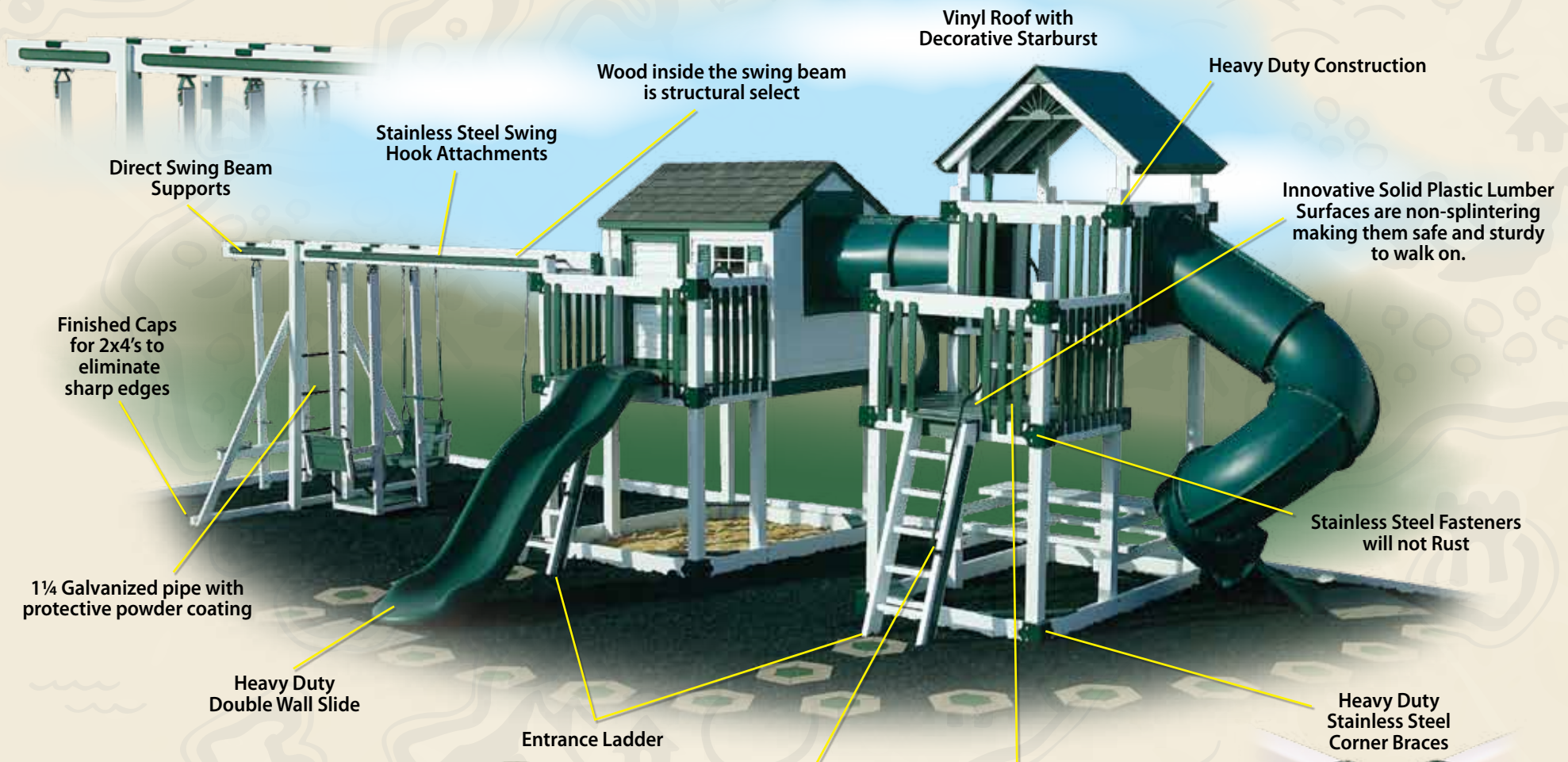

Heavy duty construction

All structural members are preserved wood encased with almond, white, or clay vinyl. All of our play systems are built with the finest materials available.

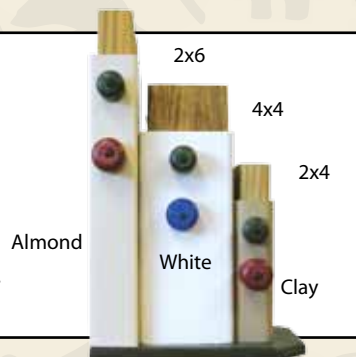

Safety Hand Rail

Safety Surface

See page 6 for color options

Heavy Duty Stainless Steel Corner Braces



frequently asked questions...

Q: Why vinyl?

A: Swing Kingdom's vinyl and decking products are the best and most uniform material available in the industry. Our vinyl is co-extruded under extreme pressure to assure a durable and beautiful finish for years to come.

Q: How strong is Swing Kingdom's vinyl?

A: Our vinyl has 5 times the tensile strength and 4 times the flexibility of wood. By combining the performance of vinyl and the sturdy characteristic of Wolmanized Natural Select outdoor wood, we create a swing set that is built to last.

Q: Will Swing Kingdom's vinyl turn yellow?

A: No. Our products contain an extremely effective UV inhibitor that offers more than enough protection from the sun's ultraviolet rays.

Q: Are Swing Kingdom's swing sets easy to maintain?

A: Yes. Very easy. If your swing set does become dirty, revitalize its appearance and make it look like new with the use of only a garden hose and some glass cleaner with a soft bristled brush to wash dirt and debris away.

Q: Are surface checks and cracks or knotty appearances normal?

A: No. Your swing set will have a clean and smooth finish for years to come.

Q: Does our yard need to be level?

A: We recommend that your site be level for the appearance and safety of your system. It is important to have a level area, at least three feet larger all the way around, prepared before delivery.

Q: Why do you cover the wood?

A: The wooden structural elements of your home are covered to preserve, and reduce maintenance. This same philosophy is used for Swing Kingdom's vinyl play systems.



add a splash of color!



almond & green



almond, yellow, & red



clay, yellow, & red



white & green



white & blue



clay & green





a-1 standard climber
page 8



a-4 special
page 9



a-5 white tower
page 10



kc-1 clubhouse
page 11



kc-2 deluxe
page 12



kc-5 deluxe
page 13



kc-8 voyager
page 14



kc-10 economy turbo
page 15



Lasting Beauty!



A-1 standard climber



ITEM #: A-1

OVERALL DIMENSIONS:

12'8" w x 14' d x 8'2" h

TOWER: 2' x 2'

DECK HEIGHT: 5'

ACCESS: Rung Climber

WEIGHT: 486 lbs.

COLOR: White PVC, Green Accents

SWING BEAM: 3 Position Climber

SLIDE: 10' Wave Slide

SWINGS:

Belt Swing, Plastic Child Swing,
Trapeze

ADD ONS:

2 Anchors

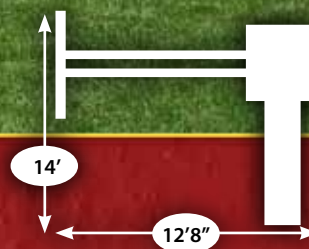

A-4 SPECIAL

ITEM #: A-4

OVERALL DIMENSIONS:

15'2" w x 15'4" d x 10'6" h

TOWER: 4' x 4'

DECK HEIGHT: 5'

ROOF: Gable Roof

ACCESS: Flat Step Ladder

WEIGHT: 721 lbs.

COLOR:

Almond PVC, Red & Yellow Accents

SWING BEAM:

3 Position Single Beam

SLIDE:

10' Rave Slide

SWINGS:

Belt Swing, Plastic Child Swing,
Plastic Glider with Adapter

ADD ONS:

2 Anchors

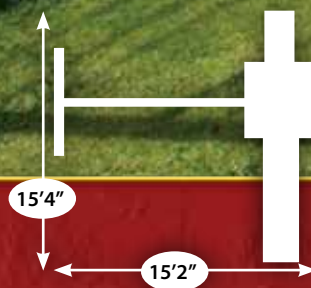

a-5 white tower



ITEM #: A-5

OVERALL DIMENSIONS:

17'6" w x 15' d x 11'2" h

TOWER: 4' x 4'

DECK HEIGHT: 5'

ROOF: 4'x4' Pyramid

ACCESS: Flat Step Ladder

WEIGHT: 878 lbs.

COLOR: White PVC, Green Accents

SWING BEAM: 3 Position Climber

SLIDE: 10' Wave Slide

SWINGS:

(2) Belt Swings, Plastic Child Swing

ADD ONS:

2 Anchors

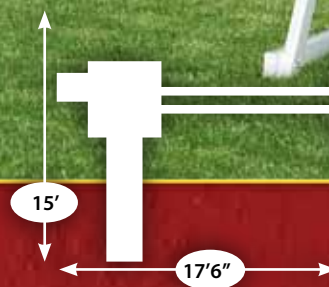

KC-1 clubhouse

ITEM #: KC-1

OVERALL DIMENSIONS:

12'w x 14'd x 12'h

TOWER: 5' x 5'

DECK HEIGHT: 5'

ROOF: Gable Roof

ACCESS: Flat Step Ladder

WEIGHT: 1,012 lbs.

COLOR: White PVC,
Green Accents

SWING BEAM:

(1) 2 Side Extension Arm

SLIDE: 10' Rave Slide

SWINGS: Belt Swing, Baby Swing

ADD ONS:

5'x5' Lower Deck, 5'x5' Clubhouse,
2 Anchors, Ship's Wheel, Binoculars

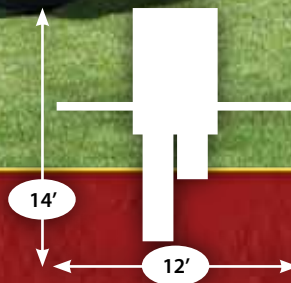

KC-2 deluxe



ITEM #: KC-2

OVERALL DIMENSIONS:

15'6" w x 15' d x 11'6" h

TOWER: 5' x 5'

DECK HEIGHT: 5'

ROOF: 5' x 5' Vinyl with Sunrise

ACCESS: Flat Step Ladder

WEIGHT: 1080 lbs.

COLOR: White PVC, Green Accents

SWING BEAM: 3 Position Climber

SLIDE: 10' Wave Slide

SWINGS:

Plastic Child Swing, Plastic Glider, Belt Swing

ADD-ONS:

Steering Wheel, Access Railings, 2 Anchors

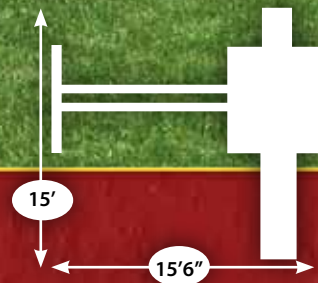

KC-5 deluxe

ITEM #: KC-5

OVERALL DIMENSIONS:

19'2" w x 15' d x 11' h

TOWER: 5' x 5'

DECK HEIGHT: 5'

ROOF: 5' x 5' Pyramid

ACCESS: Flat Step Ladder

WEIGHT: 1098 lbs.

COLOR: Almond PVC,
Green Accents

SWING BEAM: 4 Position Climber

SLIDE: 10' Rave Slide

SWINGS:

4 Rope Tire Swing, Belt Swing,
Trapeze, Plastic Glider

ADD-ONS:

2 Anchors

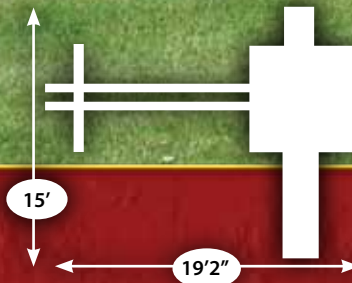

KC-8 VOYAGER



ITEM #: KC-8

OVERALL DIMENSIONS:

23'w x 16'd x 10'9"h

TOWER: 5' x 5'

TOWER EXTENSION: 3' x 5'

DECK HEIGHT: 5'

ROOF: 5' x 5' Vinyl Sunrise
3' x 5' Extension Roof

ACCESS: Flat Step Ladder

WEIGHT: 1759 lbs.

COLOR: Almond PVC, Green Accents

SWING BEAM: 4 Position Climber

SLIDE: 10' Rave Slide

SWINGS:

Plastic Glider, Trapeze, Belt Swing,
4 Rope Tire Swing

ADD-ONS: Lower Deck Railing,
2 Anchors



KC-10

economy turbo

ITEM #: KC-10

OVERALL DIMENSIONS:

25'w x 16'd x 12'6"h

TOWER: 5' x 5'

DECK HEIGHT: 5' with 7' Landing

ROOF: 5' x 5' Pyramid

ACCESS: Flat Step Ladder

WEIGHT: 1175 lbs.

COLOR: White PVC, Blue Accents

SWING BEAM:

4 Position Single Beam

SLIDES:

10' Wave Slide, Turbo Slide

SWINGS:

Plastic Child Swing, Trapeze,
Belt Swing, Daisy Disc

ADD-ONS:

2 Anchors

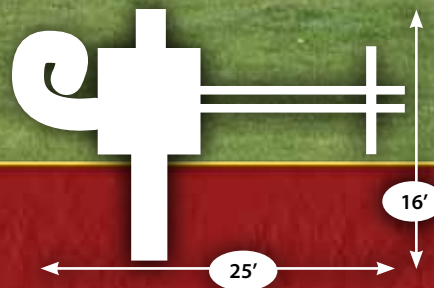



sk-1 mini mountain climber
page 17



sk-2 junior mountain climber
page 18



sk-5 mountain climber
page 19



sk-10 mountain climber
page 20



sk-15 mountain climber
page 21



sk-18 turbo mountain climber
page 22



sk-30 mega mountain climber
page 23



sk-40 rocky mountain climber
page 24



sk-50 retreat
page 25



MOUNTAIN CLIMBER SERIES™

SK-1 mini mountain climber

ITEM #: SK-1

OVERALL DIMENSIONS:

20'w x 9'6"d x 12'6"h

DECK HEIGHT: 5'

ROOF: 2' X 7' with Flags

ACCESS: Flat Step Ladder
with Hand Rail

WEIGHT: 652 lbs.

COLOR: Almond PVC,
Green Accents

SWING BEAM: 3 Position Climber

SLIDE: 10' Wave Slide

SWINGS:

Plastic Glider, Belt Swing,
Plastic Child Swing, Daisy Disc

CLIMBER:

2' x 5' Rock Wall with Rope

ADD-ONS:

Steering Wheel, Telescope,
2 Anchors

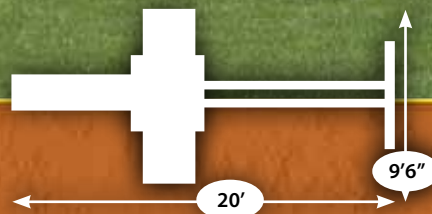

SK-2

JUNIOR mountain climber



ITEM #: SK-2

OVERALL DIMENSIONS:

20'w x 9'6"d x 12'6"h

DECK HEIGHT: 5'

ROOF: 2' X 7' with Flags

ACCESS:

Flat Step Ladder with Hand Rail

WEIGHT: 589 lbs.

COLOR: White PVC, Blue Accents

SWING BEAM:

3 Position Single Beam

SLIDE: 10' Wave Slide

SWINGS:

Trapeze, Belt Swing, Plastic Child Swing, Daisy Disc

CLIMBER:

2' x 5' Rock Wall with Rope

ADD-ONS:

Steering Wheel, 2 Anchors

OPTIONAL:

88' Regular Borders

1 Ton of Blue Rubber Mulch

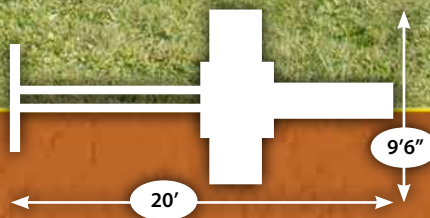

SK-5 mountain climber

ITEM #: SK-5

OVERALL DIMENSIONS:

10'w x 18'd x 12'6"h

TOWER: 5' x 5'

DECK HEIGHT: 5'

ROOF: 5' X 10' Canvas with Flags

ACCESS: Flat Step Ladder with Hand Rail

WEIGHT: 956 lbs.

COLOR: White PVC, Green Accents

SWING BEAM:

(2) 1 Position Extension Arms

SLIDE: 10' Wave Slide

SWINGS:

Trapeze, 3 Rope Tire Swing, Belt Swing

CLIMBER:

5' Rock Wall with Rope, Cargo Net

ADD-ONS:

Steering Wheel, Telescope, 2 Anchors

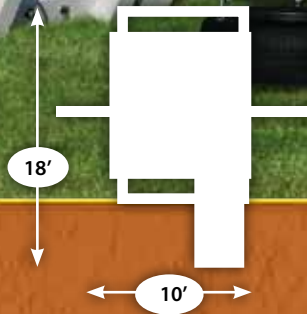

SK-10

mountain climber

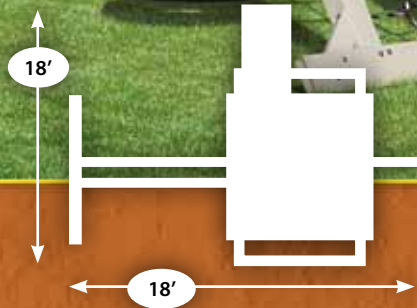

ITEM #: SK-10

OVERALL DIMENSIONS:

18'w x 18'd x 12'6"h

TOWER: 5' x 5'

DECK HEIGHT: 5'

ROOF: 5' X 10' Canvas with Flags

ACCESS: Flat Step Ladder with Hand Rail

WEIGHT: 1162 lbs.

COLOR:

Almond PVC, Red & Yellow Accents

SWING BEAM:

2 Position Climber

1 Position Extension Arm

SLIDE: 10' Wave Slide

SWINGS:

Belt Swing, Trapeze, Rubber Infant Swing, 3 Rope Tire Swing

CLIMBER:

5' Rock Wall with Rope, Cargo Net

ADD-ONS:

Steering Wheel, Telescope, 2 Anchors



SK-15 mountain climber

ITEM #: SK-15

OVERALL DIMENSIONS:

18'6" w x 18' d x 12'6" h

TOWER: 5' x 5'

DECK HEIGHT: 5'

ROOF: 5' X 10' Canvas with Flags

ACCESS: Flat Step Ladder
with Hand Rail

WEIGHT: 1241 lbs.

COLOR:

White PVC, Blue Accents

SWING BEAM:

3 Position Climber
1 Position Extension Arm

SLIDE: 10' Rave Slide

SWINGS:

Trapeze, 3 Rope Tire Swing,
Plastic Glider, Rubber Infant Swing,
Belt Swing

CLIMBER:

5' Rock Wall with Rope, Cargo Net

ADD-ONS:

Steering Wheel, Telescope,
2 Anchors

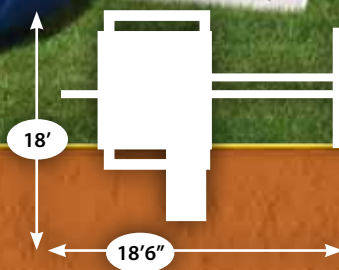

SK-18

TURBO mountain climber



ITEM #: SK-18

OVERALL DIMENSIONS:

24'w x 18'd x 12'h

TOWER: 5' x 5'

DECK HEIGHT: 5' with 7' Landing

ROOF: Gable Roof

ACCESS: Flat Step Ladder with Hand Rail

WEIGHT: 1,380 lbs.

COLOR: Almond PVC, Red & Yellow Accents

SWING BEAM: 4 Position Single Beam

SLIDES: 10' Rave Slide & Turbo Slide

SWINGS: Hammock Swing, Trapeze, Belt Swing, Plastic Child, 3 Rope Tire Swing

CLIMBER: 5' Rock Wall with Rope, Cargo Net

ADD-ONS:

Ship's Wheel, 2 Anchors

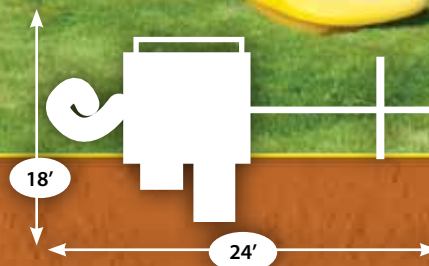

SK-30

mega mountain climber

ITEM #: SK-30

OVERALL DIMENSIONS:

24'w x 23'd x 14'h

TOWER 1: 5' x 5'

DECK HEIGHT: 5'

ROOF: 5' X 10' Canvas with Flags

ACCESS: Flat Step Ladder with Hand Rail

TOWER 2: 5' x 5'

DECK HEIGHT: 7'

ROOF: 5' X 10' Canvas with Flags

ACCESS: Flat Step Ladder

WEIGHT: 1932 lbs.

COLOR: Almond PVC, Red & Yellow Accents

SWING BEAM: 4 Position Climber

SLIDES: 14' Rave Slide, 10' Wave Slide, Turbo Slide

SWINGS: 3 Rope Tire Swing, Plastic Glider, Rubber Infant Swing, Trapeze, Belt Swing

CLIMBER: 5' Rock Wall with Rope, Cargo Net

ADD-ONS: Steering Wheel, Telescope, 2 Anchors

OPTIONAL:

112' Regular Border, 3 Ton Red Rubber Mulch

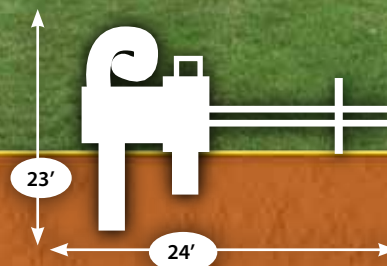

SK-40

Rocky Mountain Climber



ITEM #: SK-40

OVERALL DIMENSIONS: 30'w x 23'd x 16'h

TOWER 1: 5' x 5'

DECK HEIGHT: 5'

ROOF: 5' X 10' Canvas with Flags

ACCESS: Flat Step Ladder w/ Hand Rail

TOWER 2: 5' x 5'

DECK HEIGHT: 7'

ROOF: 5' X 10' Canvas with Flags

ACCESS: Flat Step Ladder

TOWER 3: 5' x 5'

DECK HEIGHT: 9'

ROOF: 5' X 10' Canvas with Flags

ACCESS: Flat Step Ladder

WEIGHT: 2,492 lbs.

COLOR: White PVC, Green Accents

SWING BEAMS:

4 Position Single Beam

6' Jungle Bar (No Swings)

SLIDES: 14' Rave Slide, 10' Rave Slide,
Turbo Slide

SWINGS: 3-Rope Tire Swing, (2) Belt Swing,
(1) Trapeze, (1) Rubber Infant Swing

CLIMBER: 5' Rock Wall with Rope, Cargo Net

ADD-ONS: Ship's Wheel, Telescope,
Binoculars, Free Standing Picnic Table,
Bubble Panel, 2 Anchors

OPTIONAL: 116' Stone
Borders, 3 Ton Green
Rubber Mulch



**MOUNTAIN
CLIMBER
SERIES**

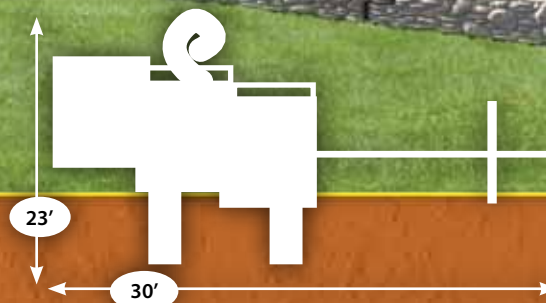

SK-50 retreat

- ITEM #:** SK-50
OVERALL DIMENSIONS: 44'w x 20'd x 14'h
TOWER 1: 5' x 5'
DECK HEIGHT: 5'
ROOF: 5' X 5' Vinyl with Sunrise
ACCESS: Flat Step Ladder w/ Hand Rail
TOWER 2: 5' x 5'
DECK HEIGHT: 7'
ROOF: 5' x 5' Vinyl with Sunrise
ACCESS: Flat Step Ladder
TOWER 3: 6' x 8' Playhouse
(5' x 6' Playhouse with 3' x 6' Porch)
DECK HEIGHT: 5'
ACCESS: Flat Step Ladder
SIDING: Clay
SHINGLES: Weatherwood Shingles
WINDOWS: 2 Windows w/ Screens
& Shutters
CONNECTOR: 5' Tower Tunnel
WEIGHT: 3,864 lbs.
COLOR: Clay PVC, Red/Yellow Accents
SWING BEAMS: 3 Position Single High Beam,
2 Position Climber, 8' Monkey Bar
(No Swing)
SLIDES: 14' Rave Slide, 10' Wave Slide
SWINGS: (2) Belt Swing - Red, (1) Baby Swing
- Yellow, (1) Trapeze, (1) Plastic Glider, 3-Rope
Tire Swing
CLIMBER: 5' Rock Wall with Rope, Cargo Net
ADD-ONS: Steering Wheel, Telescope,
2 Anchors

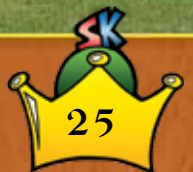
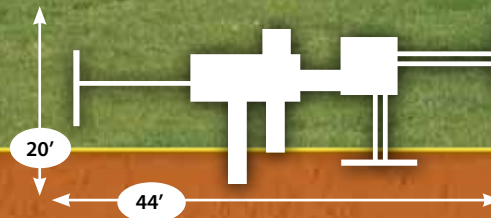



KTB-2 TURBO TOWER
page 27



A-7 DELUXE
page 28



RC-5 CHALLENGER
page 29



RL-2 TURBO TOWER
page 30



RL-3 SUPER TOWER
page 31



RL-5 COMBO TOWER
page 32



RL-10 CLIFF LOOKOUT
page 33



KTB-2 turbo tower

ITEM #: KTB-2

OVERALL DIMENSIONS:

21'w x 14'2"d x 13'h

TOWER: 4' x 8' Double

DECK HEIGHT: 5' and 7'

ROOF: 4' x 4' Vinyl with Sunrise

ACCESS: Flat Step Ladder

WEIGHT: 1,707 lbs.

COLOR: Almond PVC, Green Accents

SWING BEAM: 3 Position Climber

SLIDE: Turbo Slide

SWINGS:

(2) Belt Swing, Trapeze

CLIMBER:

7' Rock Wall with Rope

ADD-ONS:

2 Anchors

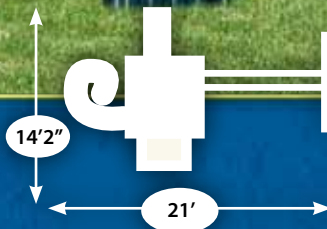

A-7 deluxe



ITEM #: A-7

OVERALL DIMENSIONS:

27'w x 21'd x 11'2"h

TOWERS: (2) 4' x 4'

DECK HEIGHT: 5'

ROOF: (2) 4' x 4' Pyramid

ACCESS: (2) Flat Step Ladders

CONNECTOR: 8' Bridge with Rope

WEIGHT: 1758 lbs.

COLOR: White PVC, Green Accents

SWING BEAM: 4 Position Climber

SLIDE: 10' Wave Slide

SWINGS:

Belt Swing, Trapeze, Deluxe Horse Rider, Plastic Child Swing

ADD-ONS:

Bubble Panel, 4' x 4' Picnic Table, 2 Anchors



RC-5 challenger

ITEM #: RC-5

OVERALL DIMENSIONS:

29'w x 29'd x 13'h

TOWERS: (2) 5' x 9' Double

DECK HEIGHT: 5' and 7'

ROOF: (2) 5' x 5' Pyramids

ACCESS: Flat Step Ladder

CONNECTORS: 5' Tower Tunnel,
5' Bridge with Rope

WEIGHT: 3191 lbs.

COLOR: Almond PVC, Green Accents

SWING BEAM: 4 Position Climber

SLIDE:

10' Rave Slide, 14' Rave Slide,
Turbo Slide

SWINGS:

(2) Belt Swing, Trapeze,
Horse Rider

CLIMBER: 7' Rock Wall with Rope

ADD-ONS:

5' x 5' Picnic Table, 2 Anchors

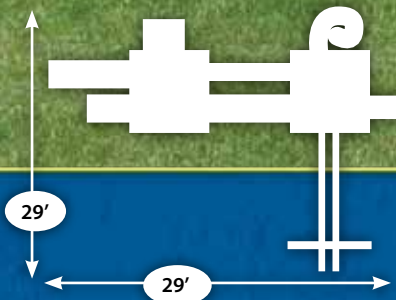

RL-2

TURBO TOWER



ITEM #: RL-2

OVERALL DIMENSIONS:

23'w x 18'd x 13'6"h

TOWER: 5' x 9' Double

DECK HEIGHT: 5' and 7'

ROOF: 5' x 5' Vinyl with Sunrise

ACCESS: Flat Step Ladder

WEIGHT: 1735 lbs.

COLOR:

Almond PVC, Red & Yellow Accents

SWING BEAM: 3 Position Single Beam

SLIDE: Turbo Slide

SWINGS:

Belt Swing, Trapeze, Daisy Disc

CLIMBER:

7' Rock Wall with Rope

ADD-ONS:

5' x 5' Picnic Table, Bubble Panel,
2 Anchors

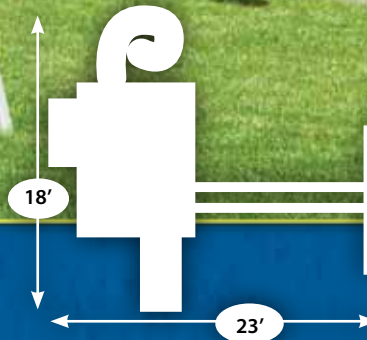

RL-3 super tower

ITEM #: RL-3

OVERALL DIMENSIONS:

31'w x 13'd x 13'6"h

TOWER: 5' x 9' Double

DECK HEIGHT: 5' and 7'

ROOF: 5' x 5' Vinyl with Sunrise

ACCESS: Flat Step Ladder

WEIGHT: 1682 lbs.

COLOR: White PVC, Blue Accents

SWING BEAM: 4 Position Climber

SLIDE: 14' Rave Slide

SWINGS:

(2) Belt Swing,
Rubber Infant Swing,
4 Rope Tire Swing

CLIMBER:

5' Rock Wall with Rope

ADD-ONS:

2 Anchors



RL-5 COMBO TOWER



ITEM #: RL-5

OVERALL DIMENSIONS:

25'w x 24'd x 13'6"h

TOWER 1: 5' x 9' Double

DECK HEIGHT: 5' and 7'

ROOF: 5' x 5' Vinyl with Sunrise

ACCESS: Flat Step Ladder

TOWER 2: 5' x 5'

DECK HEIGHT: 5'

ROOF: 5' x 5' Vinyl with Sunrise

ACCESS: Flat Step Ladder

WEIGHT: 2681 lbs.

COLOR: White PVC, Green Accents

SWING BEAM: 3 Position Climber

SLIDES: 10' Wave Slide, Turbo Slide

SWINGS: Belt Swing, Plastic Glider,
Plastic Child Swing

CLIMBER: 7' Rock Wall with Rope,
Cargo Net

ADD-ONS: 5' x 5' Picnic Table,
Steering Wheel, Periscope,
(2) Access Railings, 2 Anchors

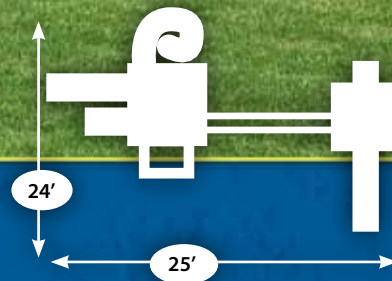

RL-10 cliff lookout

ITEM #: RL-10

OVERALL DIMENSIONS:

24'w x 22'd x 16'h

TOWER 1: 4' x 5'

DECK HEIGHT: 5'

ACCESS: 12' Ramp

TOWER 2: 5' x 5'

DECK HEIGHT: 7'

ACCESS: Flat Step Ladder

ROOF: Gable Roof

TOWER 3: 5' x 5'

DECK HEIGHT: 9'

ACCESS: Flat Step Ladder

ROOF: Gable Roof

WEIGHT: 2,432 lbs.

COLOR: Almond PVC, Red & Yellow Accents

SWING BEAM: 3 Position 10' High Single Beam, 6' Jungle Bar (No Swings)

SLIDE: 14' Rave Slide

SWINGS: (2) Belt Swing, Trapeze

CLIMBER: 5' Rock Wall with Rope

ADD-ONS: 5' x 5' Lower Deck, 5' x 5' Clubhouse, Tic-Tac-Toe Panel, Steering Wheel, Binoculars, Periscope, Bubble Panel, 2 Anchors





C-1 hideout
page 35



C-2 turbo
escape
page 36



C-3 hideout
page 37



C-4 hideout
page 38



C-5 castle
page 39



C-8 BRIDGE escape
page 40



C-3 tunnel escape
page 41



KRC extreme
page 42 & 43



sk-60 cottage escape
page 44



C-1 hideout

ITEM #: C-1

OVERALL DIMENSIONS:

17'w x 17'd x 10'10"h

TOWER: 6' x 8' Playhouse

DECK HEIGHT: 5'

ACCESS: Flat Step Ladder

WEIGHT: 1597 lbs.

COLOR: Almond PVC, Green Accents

SWING BEAM: 3 Position Climber

SLIDE: 10' Rave Slide

SWINGS:

(2) Belt Swing, Trapeze

PLAYHOUSE:

5' x 6', 3' x 6' Porch

Almond Siding, Black Shingles

2 Windows with Screens

& Shutters

ADD ONS: 2 Anchors

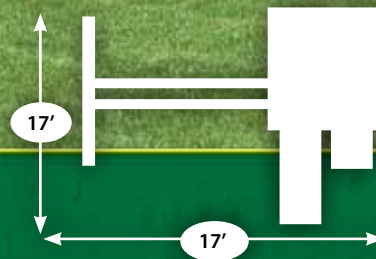

C-2

TURBO ESCAPE



ITEM #: C-2

OVERALL DIMENSIONS:

23'w x 20'd x 10'6"h

TOWER: 6' x 8' Playhouse

DECK HEIGHT: 5'

ACCESS: 12' Ramp

WEIGHT: 1,889 lbs.

COLOR: Almond PVC, Green Accents

SWING BEAM: 3 Position Climber

SLIDE: 10' Wave Slide, Turbo Slide

SWINGS:

Horse Rider, Belt Swing, Trapeze

PLAYHOUSE:

5' x 6', 3' x 6' Porch, Almond PVC,
Clay Siding, Tan Shingles, 2 Windows
with Screens & Shutters

ADD ONS: 2 Anchors

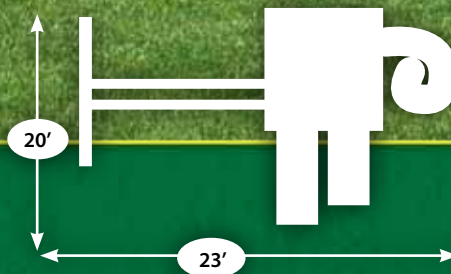

C-3 hideout

ITEM #: C-3

OVERALL DIMENSIONS:

20'w x 17'd x 10'6"h

TOWER: 6' x 8' Playhouse

DECK HEIGHT: 5'

ACCESS: Flat Step Ladder

WEIGHT: 1,847 lbs.

COLOR: White PVC, Green Accents

SWING BEAM: 4 Position Climber

SLIDE: 10' Rave Slide

SWINGS:

Horse Rider, Basket Glider,
Belt Swing, Trapeze

PLAYHOUSE:

5' x 6', 3' x 6' Porch,
White Siding, Weatherwood
Shingles, 2 Windows with Screens
& Shutters

ADD-ONS:

Steering Wheel, Access Railing,
2 Anchors

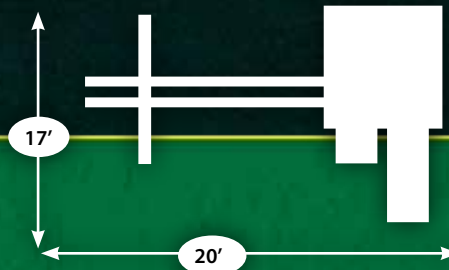

C-4 hideout



ITEM #: C-4

OVERALL DIMENSIONS:

22'w x 19'd x 10'6"h

TOWER: 6' x 8' Playhouse

DECK HEIGHT: 5'

ACCESS:

5' Access Ladder with Access Railing

WEIGHT: 1,625 lbs.

COLOR: Almond PVC, Green Accents

SWING BEAM: 3 Position Single Beam

SLIDE: 10' Wave Slide

SWINGS:

2 Belt Swings, Trapeze

CLIMBER: 5' Rock Wall with Rope

PLAYHOUSE:

5' x 6', 3' x 6' Porch,
Almond Siding, Weatherwood
Shingles, 2 Windows with
Screens & Shutters

ADD-ONS: Binoculars, 2 Anchors

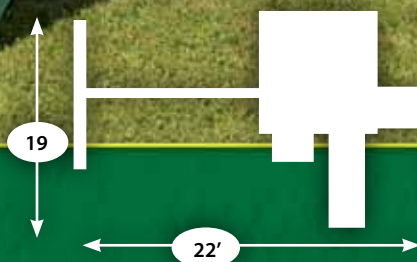

C-5 castle

ITEM #: C-5

OVERALL DIMENSIONS:

23'w x 20'd x 11'h

TOWER 1: 6' x 8' Playhouse

DECK HEIGHT: 5'

ACCESS: Flat Step Ladder

TOWER 2: 5' x 5'

DECK HEIGHT: 5'

ROOF: 5' x 5' Pyramid

ACCESS: Flat Step Ladder

WEIGHT: 2,416 lbs.

COLOR: White PVC, Blue Accents

CONNECTOR: 8' Bridge with Rope

SWING BEAM: 3 Position Climber

SLIDE: 10' Wave Slide

SWINGS:

Plastic Glider, Trapeze, Belt Swing

PLAYHOUSE:

5' x 6' with 3' x 6' Porch, White Siding, Blue Shingles, 2 Windows with Screens & Shutters

ADD-ONS: 5' x 6' Picnic Table,
2 Anchors

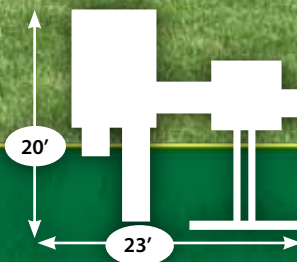

C-8 BRIDGE escape



ITEM #: C-8

OVERALL DIMENSIONS:

32'w x 18'd x 12'6''h

TOWER 1: 5' x 5'

DECK HEIGHT: 5'

ROOF: 5' x 10' Canvas with Flag

ACCESS: Flat Step Ladder with Hand Rail

TOWER 2: 6' x 8'

DECK HEIGHT: 5'

ACCESS: 5' Flat Step Ladder with Access Railing

CONNECTOR: 8' Bridge with Rope

WEIGHT: 2,580 lbs.

COLOR: Almond PVC, Green Accents

SWING BEAM: 3 Position Single Beam, 2 Position Single Beam

SLIDE: 10' Rave Slide

SWINGS: Baby Swing, Trapeze, Belt Swing, 3 Rope Tire Swing with Swivel, Fan Back Lawn Swing

ADD-ONS: 2 Binoculars, 1 Ship's Wheel, 5' Rock Wall with Rope, Cargo Net, 2 Anchors

PLAYHOUSE: 5' x 6' with 3' x 6' Porch, Almond Siding, Weatherwood Shingles, 2 Windows with Screens & Shutters

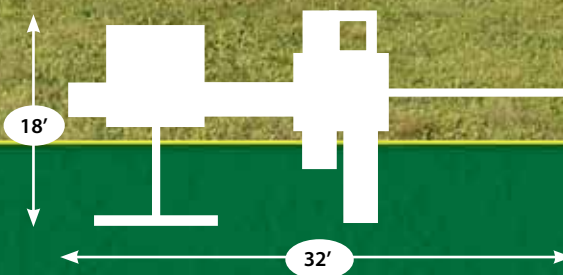

C-3 tunnel escape

ITEM #: C-3

OVERALL DIMENSIONS:

36'w x 17'd x 13'h

TOWER 1: 6' x 8' Playhouse

DECK HEIGHT: 5'

ACCESS: Flat Step Ladder

TOWER 2: 5' x 9' Double

DECK HEIGHT: 5' and 7'

ROOF: 5' x 5' Vinyl with Sunrise

ACCESS: Flat Step Ladder

WEIGHT: 3,416 lbs.

COLOR: White PVC, Green Accents

CONNECTOR: 5' Tower Tunnel

SWING BEAM: 4 Position Climber

SLIDES: 10' Rave Slide, Turbo Slide

SWINGS: Horse Rider, Basket Glider,
Trapeze, Belt Swing

ADD-ONS: 5' x 5' Picnic Table,
Bubble Panel, Periscope, Steering
Wheel, (2) Access Railings, 2 Anchors

PLAYHOUSE: 5' x 6' with 3' x 6' Porch,
White Siding, Weatherwood Shingles,
2 Windows with Screens & Shutters

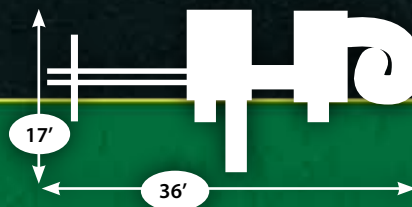

playhouse



ITEM #: KRC

OVERALL DIMENSIONS:

52'w x 23'd x 13'10"h

TOWER 1: 6' x 8' Playhouse

DECK HEIGHT: 5'

ACCESS: 12' Ramp

TOWER 2: 5' x 9' Double

DECK HEIGHT: 5' and 7'

ROOF: 5' X 5' Pyramid

ACCESS: Flat Step Ladder

TOWER 3: 4' x 8' Double

DECK HEIGHT: 5' and 7'

ROOF: 4' X 4' Vinyl with Sunrise

EXTENSION ROOF: 4' X 4' Vinyl

ACCESS: Flat Step Ladder

CONNECTORS:

12' Bridge with Rope
5' Tower Tunnel

WEIGHT: 5283 lbs.

COLOR: Almond PVC,
Green Accents

SWING BEAMS:

4 Position Climber, 3
Position Single High Beam

SLIDES: 10' Rave Slide,
Turbo Slide, 14' Rave Slide

SWINGS: Plastic Child
Swing, Trapeze, (3) Belt
Swings, Plastic Glider,
2-Rope Tire Swing

CLIMBER:

Cargo Net, 5' Rock Wall
with Rope

ADD-ONS:

5' x 5' Picnic Table,
4' x 4' Picnic Table,
Steering Wheel,
Periscope, 2 Anchors

PLAYHOUSE: 5' x 6' with
3' x 6' Porch, Almond
Siding, Black shingles,
2 Windows with Screens
& Shutters, Flower Box



KRC extreme

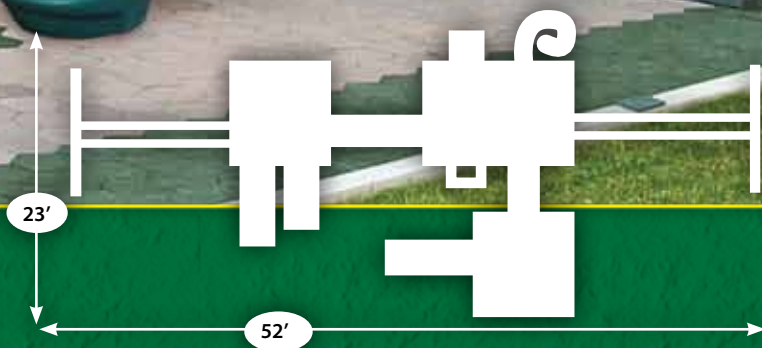

SK-60

cottage escape



ITEM #: SK-60

OVERALL DIMENSIONS: 37'w x 24'd x 14'h

TOWER 1: 5' x 5'

DECK HEIGHT: 5'

ROOF: 5' x 10' Canvas with Flags

ACCESS: Flat Step Ladder with Hand Rail

TOWER 2: 5' x 5'

DECK HEIGHT: 7'

ROOF: 5' x 10' Canvas with Flags

ACCESS: Flat Step Ladder

TOWER 3: Playhouse, 8' x 8' with 4' x 8' Porch, Weatherwood Shingles, 3 Windows with Screens and Shutters, Door

WEIGHT: 4,628 lbs.

CONNECTOR: 5' Tower Tunnel

COLOR: Almond PVC, Red & Yellow Accents

SWING BEAM: 4 Position Climber

SLIDES: 14' Rave Slide, 10' Rave Slide, Turbo Slide

SWINGS: Hammock Swing, 3-rope Tire, Plastic Glider, Baby Swing, Trapeze, Belt Swing

CLIMBER: 5' Rock Wall with Rope & Cargo Net

ADD-ONS: Ship's Wheel, Periscope, Balance Board, 2 Anchors

OPTIONAL: 96' Stone Borders, 2 Ton Red Mulch

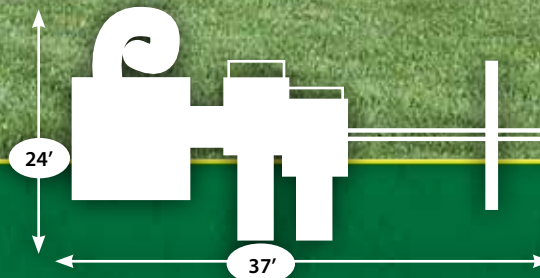



how to create your own gym set...

Select a popular model from the pages of our catalog.

OR

Start with a catalog model and add or exchange from our many options.

OR

Start with a tower and follow the steps below to create your own swing set.

Any way you design it, with Swing Kingdom it's simple, fun and just the way you want it!

step 1 choose your tower



2'x2' Tower



4'x4' Tower



5'x5' Tower



4'x8' Double



5'x9' Double



Mountain Climber
5' Deck Height



Playhouse Tower
5' Deck Height



Playhouse
8' x 8'
with 4' x 8' Porch



Mega Climber



Rocky Mountain
Climber

add a
2nd tower
with a connector
OR SWING BEAM!



Bridge with Rails
5', 8', 12'



Bridge 5', 8', 12'

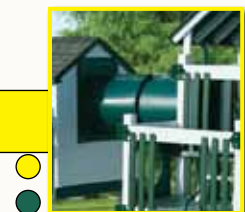

Tunnel

step 2 choose a roof style



Pyramid Roof
4' x 4', 5' x 5'



Vinyl Roof
4' x 4', 5' x 5'



Gable Roof
4' x 4', 5' x 5'

Extension Roofs

Over Ground
Level Deck

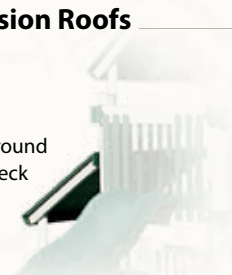

Over Double Tower

step 3 choose your access

Flat Step Ladder

Ensure a safe entry into your tower by using one of our machine-routed heavy duty access ladders. Complete with trim & precut non-skid strips (Pictured with optional Access Railing)

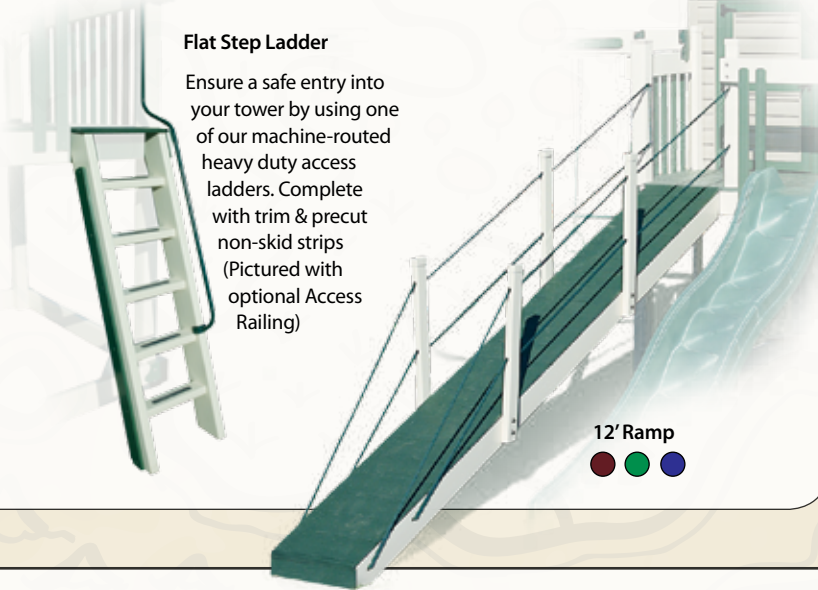

12' Ramp
● ● ●

step 4 choose your color

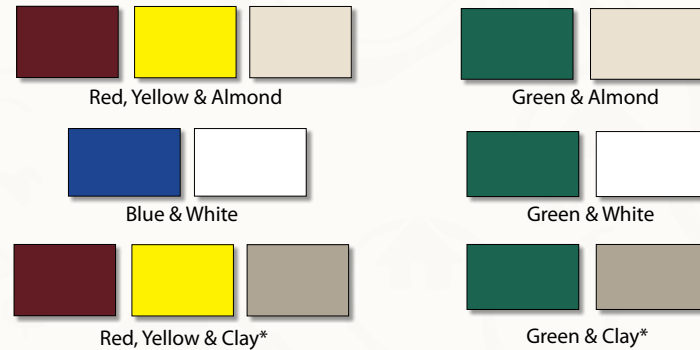

*Additional Charge for Clay

step 5 choose your swing beam

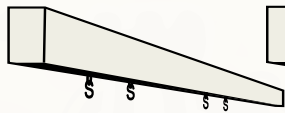

Two Position
8' Single Beam

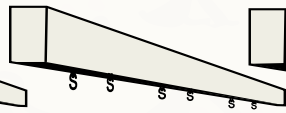

Three Position
10'6" Single Beam

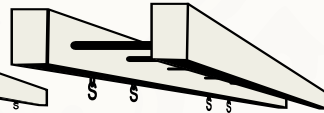

Two Position
Climber 8'

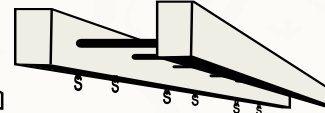

Three Position
Climber 10'6"

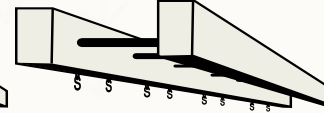

Four Position
Climber 14'

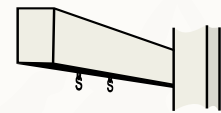

One Position
Extension Arm 36"



Jungle Bar
4'W, 6'L, 8'H

step 6 choose a slide

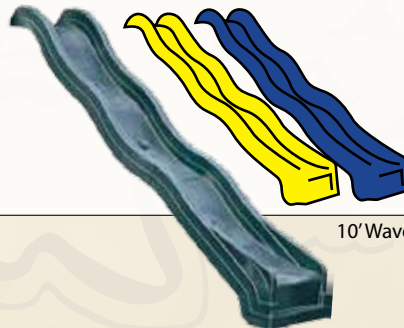

10' Wave Slide

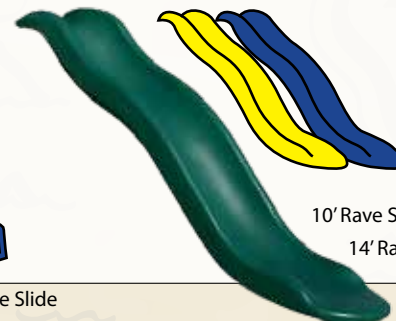

10' Rave Slide
14' Rave Slide

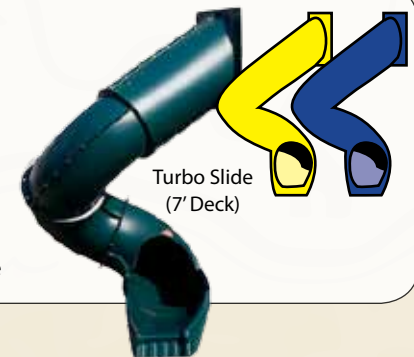

Turbo Slide
(7' Deck)

step 7 choose your swings

(Don't forget to order additional swings to accommodate your child's growth)



Belt Swing
● ● ● ●



Trapeze
● ● ● ●



Plastic Child Swing
● ● ● ●



Rubber Infant Swing
● ● ● ●



Baby Swing
● ● ● ●



Hammock Swing



Spring Swing
● ● ● ●



Daisy Disc
● ● ● ●



Buoy Ball
● ● ● ●



Trapeze Buoy Ball Combo
● ● ● ●



Two Rope Tire Swing

Tire swing ropes are available in red, green and blue



3 Rope Tire Swing with Swivel



Heavy Duty Swing Hanger

Items pictured below are for use with a climber beam or a single beam with a four point swing adapter.



Plastic Glider
● ● ● ●



Four Rope Tire Swing



Four Point Swing Adapter

Items pictured below are only for use with a climber beam and a 5' deck

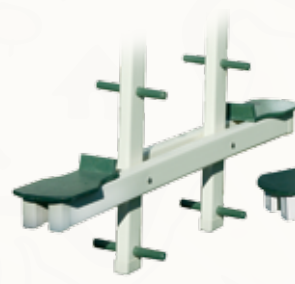

Horse Rider
● ● ● ●



Deluxe Horse Rider
● ● ● ●



Basket Swing
● ● ● ●

step 8 choose your climber

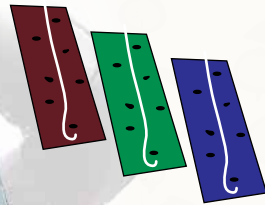

Rock Wall
5' & 7'

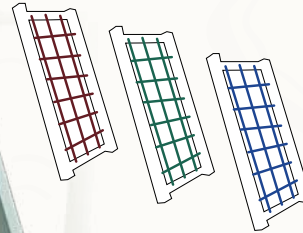
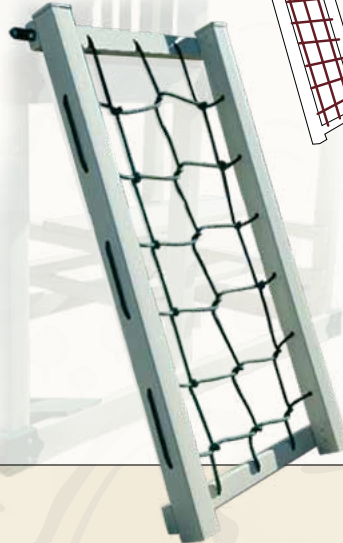

5' Cargo Net



step 9 choose your playhouse options

Shingle Colors



Vinyl Siding Colors



Slider Windows with Screens

Our windows are fully functional & include a screen & two shutters (Flower Box is optional).

Colors May Vary

step 10 finishing touches

Fanny Pad
24" x 38"



Standard
Landscape Timber
6" h x 4' l



Rock shaped
Landscape Timber
8" h x 4' l

Mulch Colors

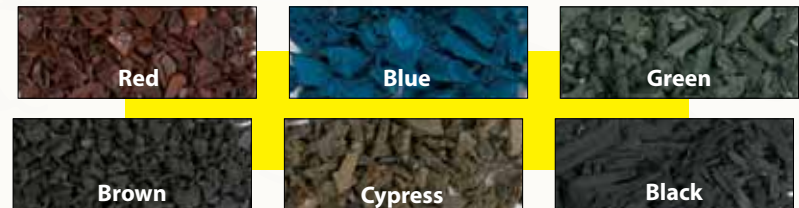

1 ton of mulch covers 250 square feet at 3" thick. Only available in 1 ton increments.

step 11 choose your fun add-on options



Steering Wheel



Periscope



Telescope



Binoculars



Ship's Wheel



Water Slide Adapter



Weather vane



Bubble Panel



Tic-tac-toe Panel

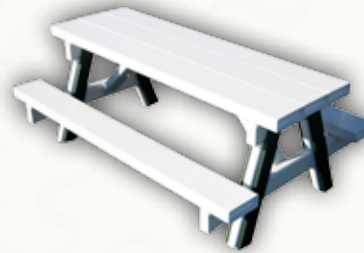

Free-standing Picnic Table
5'L x 3'W x 30"H

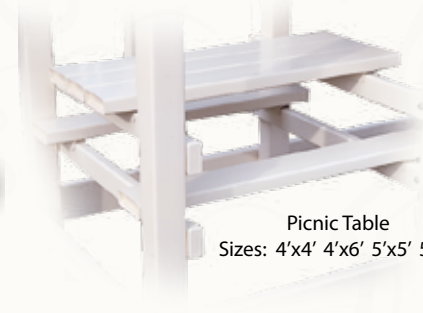

Picnic Table
Sizes: 4'x4' 4'x6' 5'x5' 5'x6'

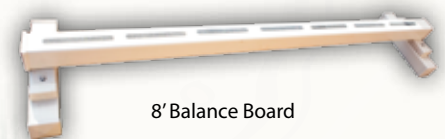

8' Balance Board



Sandbox Cover
Sizes: 4'x4' 4'x8' 5'x5' 5'x8' 6'x8'



Anchors



Hand Rail



Access Railing



Lower Deck Railing



5'L x 5'W x 5'H, 5'L x 5'W x 7'H
Clubhouse

no painting or staining

no splinters or rotting

& saves time & money!

thank you...

*for choosing our line of swing sets, to enhance your back yard,
and provide your children with the safest swing set possible.*

*Let us supply you with the value and comfort of a
NON-SPLINTERING, LOW MAINTENANCE SWING SET that your children
will cherish for years. Our goal is to provide you with safety and comfort.*

Unlike wood, our vinyl decks will remain smooth to the touch.

*The innovative SLIP RESISTANT surface is
NON-SPLINTERING, making it safe and comfortable to walk on.
The non-toxic, non-absorbent vinyl material does not require the
maintenance time and harsh chemical treatments that are a must
with wooden play sets. For maximum value we have used
stainless steel lags, bolts & screws.*

WE APPRECIATE YOUR INTEREST!



Limited Lifetime, 20 Year & 5 Year Warranty

Subject to ordinary use and proper installation

Swing Kingdom warrants to the original purchaser at the original installation address, that the structural components of the playground systems, such as the PVC plastic lumber and wood components are covered by a 20-year warranty. In addition, all canopies, slides, metal components, swings and accessories are warranted for 5 years from date of original purchase.

The manufacturer's products are not warranted as being suitable for a particular purpose. The suitability of the product is for the purchaser to determine. This warranty does not cover normal wear and tear, failure to properly maintain the product, or damage resulting from misuse or abuse of the product, additionally any acts of nature such as lightning, storms, hurricanes, tornados, earthquakes or any extreme weather conditions. Also any alteration, addition or relocation of the product will void this warranty.

Swing Kingdom reserves the right to examine photographs and/or physical evidence of the product claimed to be defective, and to recover product prior to any warranty claims. All products returned for inspection must be sent freight prepaid. In the event of a defect covered by these warranties, Swing Kingdom will remedy the defect within a reasonable time. The remedy will consist of repair or replacement of the defective piece unless it is not practical. Then Swing Kingdom will reimburse the original purchaser for the value of the defective piece.

Adult supervision is recommended while enjoying your play system.

For safety and comfort reasons, the manufacturer reserves the right to make design & construction changes without notice.

Lawn Swings



Straight Back Lawn Swing
8'H x 8'L x 9'D - White & Green
Approximate Weight: 460 lb.



Fan Back Lawn Swing
8'H x 8'L x 9'D - Almond & Green
Approximate Weight: 460 lb.



Canopy Glider
7'5"H x 9'4"L x 6'5"D - Almond & Red
Approximate Weight: 625 lb.

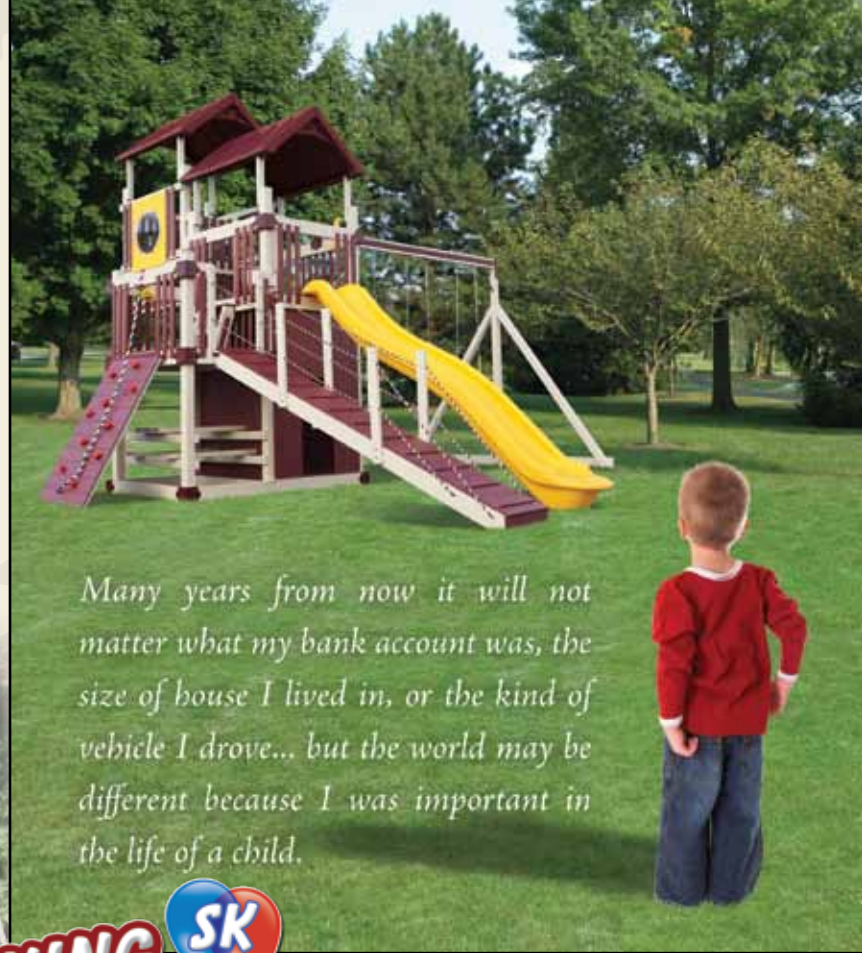

Many years from now it will not matter what my bank account was, the size of house I lived in, or the kind of vehicle I drove... but the world may be different because I was important in the life of a child.



Dealer Contact: